

SharkBite®

Brass Fittings

SharkBite® PEX crimp fittings are designed for use with all PEX tubing and must be used in conjunction with SharkBite crimp/clamp rings and press sleeves. SharkBite PEX crimp fittings have a 25-year system warranty when used with SharkBite PEX tubing.

Applications

Residential and commercial potable water, recirculation, reclaimed water systems, hydronic heating/cooling (up to 50% glycol concentration).

Specifications Data

Materials		
Body		C69300 Lead-Free DZR Silicon Brass

Performance		
Max Working Pressure		
80 psi	at	200°F
100 psi	at	180°F
160 psi	at	73.4°F

*Max Working Pressure for CPVC Socket Adapters is 80 psi at 180°F

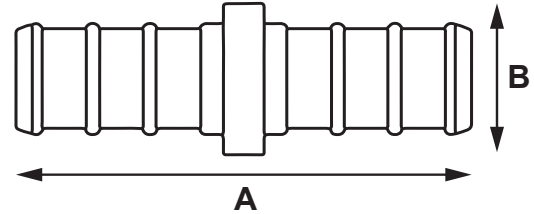

Couplings

Dimensions (Inches)			
Part #	Size	A	B
UC006LF	3/8 in.	1.4	0.5
UC008LF	1/2 in.	1.4	0.5
UC012LF	5/8 in.	1.4	0.7
UC016LF	3/4 in.	1.4	0.8
UC020LF	1 in.	1.8	1.1
UC0135	1-1/4 in.	2.0	1.1
UC0141	1-1/2 in.	2.6	1.3
UC0154	2 in.	3.4	1.7

Certifications & Listings

ASTM F1807, ASTM F877, ASTM E84, ASTM E119, CSA B137.5, NSF/ANSI 14, NSF/ANSI/CAN 61, NSF/ANSI/CAN 372, CAN/ULC S102.2, CAN/ULC S101

CPVC Socket Adapters are listed to ASTM D2846, Copper Press Adapter are listed to IAPMO Z1117

For listing information, please contact Customer Service

US 1-877-700-4242 | sharkbite.com
 Canada 1-888-820-0120 | canadasales@rwc.com

Product Submittal	
Name	
Date	
Architect/Owner	
Contractor	
Tag	
Notes	

Reducing Couplings

Dimensions (Inches)			
Part #	Size	A	B
UC009LF	3/8 in. x 1/2 in.	1.4	0.5
UC058LF	1/2 in. x 3/4 in.	1.4	0.8
UC057LF	3/4 in. x 5/8 in.	1.4	0.8
UC060LF	3/4 in. x 1 in.	1.6	1.1
UC013522	1-1/4 in. x 3/4 in.	1.7	1.1
UC013528	1-1/4 in. x 1 in.	1.9	1.1
UC014122	1-1/2 in. x 3/4 in.	2.0	1.3
UC014128	1-1/2 in. x 1 in.	2.1	1.3
UC014135	1-1/2 in. x 1-1/4 in.	2.4	1.3
UC015441	2 in. x 1-1/2 in.	3.1	1.7

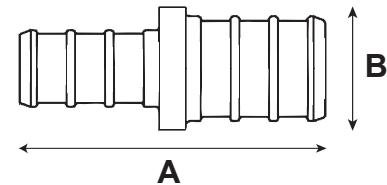

Sweat Female Adapters

Dimensions (Inches)			
Part #	Size	A	B
UC600LF	1/2 in.	1.3	0.7
UC606LF	3/4 in.	1.5	1.0
UC605LF	1 in.	1.9	1.3

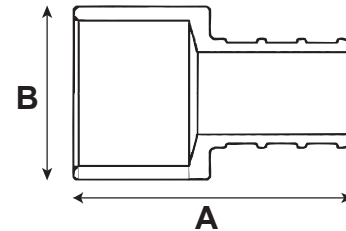

Sweat Male Adapters

Dimensions (Inches)			
Part #	Size	A	B
UC607LF	1/2 in.	1.2	0.6
UC608LF	3/4 in.	1.5	0.9
UC609LF	1 in.	1.8	1.1

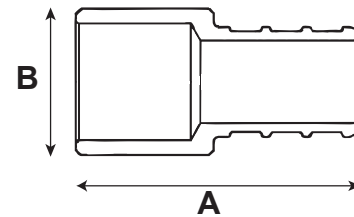

Female Adapters

Dimensions (Inches)			
Part #	Size	A	B
UC093LFA	1 in. Crimp x 3/4 in. FNPT	1.6	1.2

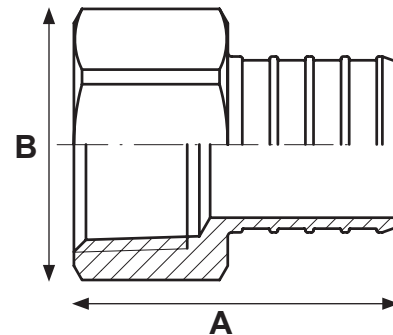

CPVC Socket Adapters

Dimensions (Inches)			
Part #	Size	A	B
UC916LFA	1/2 in.	2.0	1.1
UC922LFA	3/4 in.	2.2	1.4
UC928LFA	1 in.	2.6	1.6

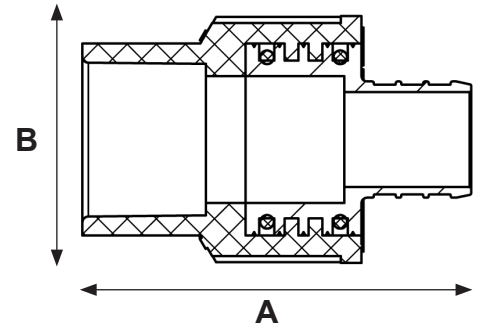

Copper Press Adapters

Dimensions (Inches)			
Part #	Size	A	B
UC716LFA	1/2 in.	1.8	0.7
UC722LFA	3/4 in.	1.9	1.0
UC728LFA	1 in.	2.1	1.3

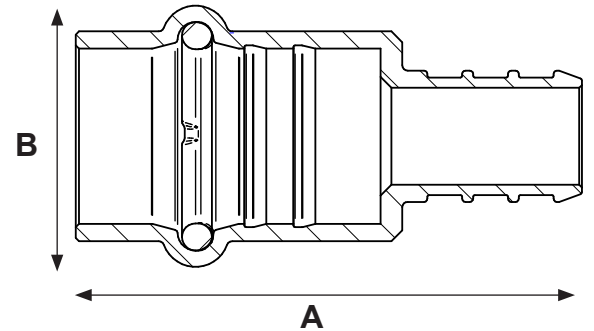

Polybutylene Adapters

Dimensions (Inches)			
Part #	Size	A	B
UC4006LF	3/8 in.	1.4	0.6
UC4008LF	1/2 in.	1.4	0.8
UC4016LF	3/4 in.	1.4	1.0

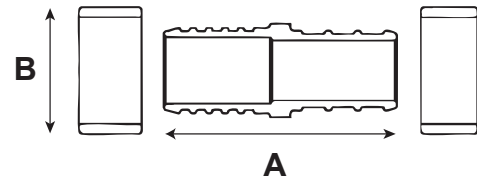

Swivel Adapters

Dimensions (Inches)			
Part #	Size	A	B
UC526LF	1/2 in. x 1/2 in. NPSM Swivel Adapter	1.4	1.3
UC527LF	3/8 in. X 1/2 in. NPSM Swivel Adapter	1.5	1.3
UC534LF	1/2 in. X 3/4 in. NPSM Swivel Adapter	1.3	1.1
UC594LF	1 in. X 1 in. NPSM Swivel Adapter	1.6	1.5
UC529LF	3/4 in. X 1 in. NPSM Swivel Adapter	1.4	1.5
UC530LF	3/4 in. X 3/4 in. NPSM Swivel Adapter	1.3	1.1

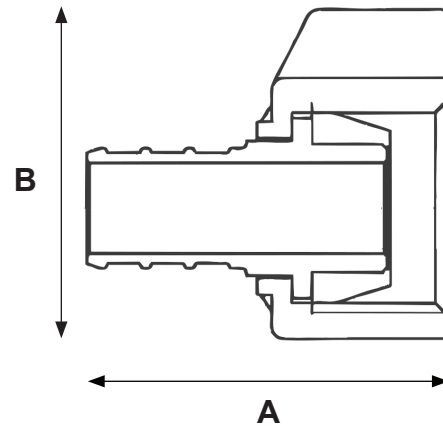

Brass Crimp Female Connectors

Dimensions (Inches)			
Part #	Size	A	B
UC068LF	1/2 in. x 3/4 in. FNPT	1.4	1.3
UC072LF	1/2 in. x 1/2 in. FNPT	1.3	1.1
UC088LF	3/4 in. x 3/4 in. FNPT	1.4	1.3
UC094LF	1 in. x 1 in. FNPT	1.7	1.7
UC092LF	3/4 in. x 1/2 in. FNPT Bullnose	1.3	1.1
UC113532F	1-1/4 in. x 1-1/4 in. FNPT	1.9	1.9
UC114140F	1-1/2 in. x 1-1/2 in. FNPT	2.3	2.3
UC115450F	2 in. x 2 in. FNPT	2.7	2.6

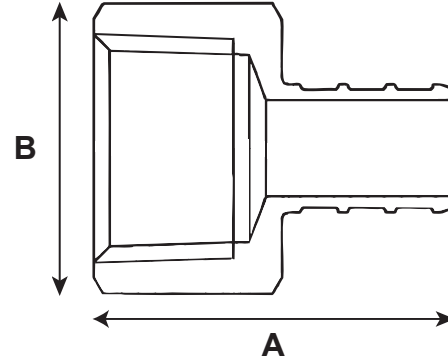

Brass Crimp Male Connectors

Dimensions (Inches)			
Part #	Size	A	B
UC118LF	3/8 in. x 1/2 in. MNPT	1.4	1.0
UC120LF	1/2 in. x 1/2 in. MNPT	1.4	1.0
UC126LF	5/8 in. x 3/4 in. MNPT	1.6	1.2
UC116LF	1/2 in. x 3/4 in. MNPT	1.6	1.2
UC138LF	3/4 in. x 1/2 in. MNPT	1.4	1.0
UC134LF	3/4 in. x 3/4 in. MNPT	1.6	1.2
UC139LF	3/4 in. x 1 in. MNPT	1.7	1.5
UC142LF	1 in. x 3/4 in. MNPT	1.8	1.2
UC140LF	1 in. x 1 in. MNPT	1.9	1.5
UC113532M	1-1/4 in. x 1-1/4 in. MNPT	2.1	1.7
UC114140M	1-1/2 in. x 1-1/2 in. MNPT	2.4	2.0
UC115450M	2 in. x 2 in. MNPT	3.1	2.4

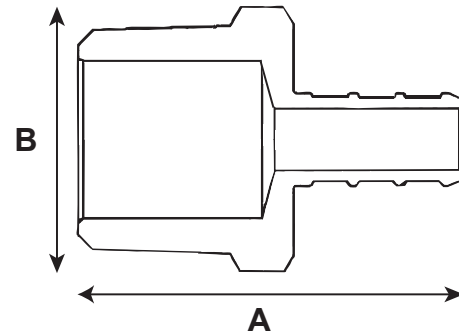

Swivel Toilet Connectors

Dimensions (Inches)			
Part #	Size	A	B
UC528LF	1/2 in. X 7/8 in. BC Straight	1.5	1.1
23067LF	1/2 in. X 7/8 in. BC Elbow	1.9	1.3

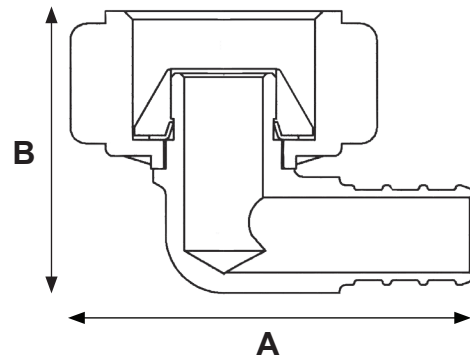

90° Elbows

Dimensions (Inches)			
Part #	Size	A	B
UC246LF	3/8 in.	1.1	1.1
UC248LF	1/2 in.	1.2	1.2
UC256LF	3/4 in.	1.4	1.4
UC260LF	1 in.	1.4	1.4
UC0235	1-1/4 in.	2.2	2.2
UC0241	1-1/2 in.	2.7	2.7
UC0254	2 in.	3.5	3.5
UC252LF	5/8 in.	1.3	1.3
UC256LF	3/4 in.	1.4	1.4

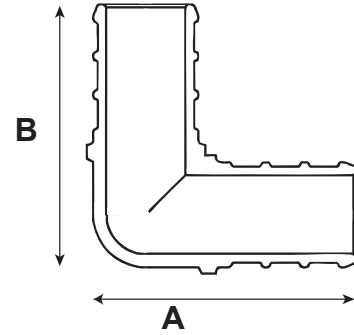

Reducing Elbows

Dimensions (Inches)			
Part #	Size	A	B
UC272LF	1/2 in. x 3/8 in.	1.2	1.2
UC274LF	1/2 in. x 3/4 in.	1.4	1.2
UC273LF	3/4 in. x 5/8 in.	1.4	1.3

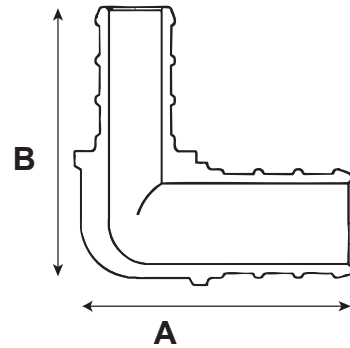

Drop Ear Elbows

Dimensions (Inches)			
Part #	Size	A	B
UC334LF	1/2 in. x 1/2 in.	2.3	1.1
UC340LF	3/4 in. x 3/4 in.	2.5	1.4
UC342LF	3/4 in. x 1/2 in.	2.3	1.3

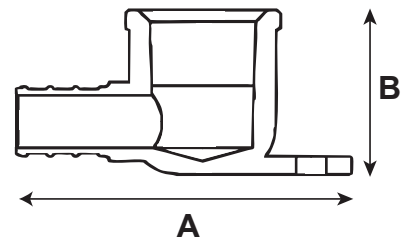

Adapter Elbows

Dimensions (Inches)			
Part #	Size	A	B
UC280LF	1/2 in. x 1/2 in. MNPT Adapter	1.4	1.2
UC278LF	1/2 in. x 3/4 in. MNPT Adapter	1.6	1.3
UC286LF	3/4 in. x 3/4 in. MNPT Adapter	1.7	1.5
UC308LF	1/2 in. X 1/2 in. FNPT Adapter	1.3	1.0
UC314LF	3/4 in. X 3/4 in. FNPT Adapter	2.1	1.3
UC626LF	3/4 in. x 3/4 in. Female Sweat Adapter	1.6	1.8
UC628LF	3/4 in. x 3/4 in. Male Sweat Adapter	1.6	1.7

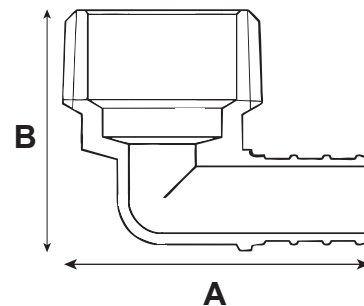

Swivel Elbows

Dimensions (Inches)				
Part #	Size	A	B	
UC531LF	3/8 in. X 1/2 in. NPSM Swivel Elbow	1.3	1.9	
UC532LF	1/2 in. X 1/2 in. NPSM Swivel Elbow	1.3	1.9	

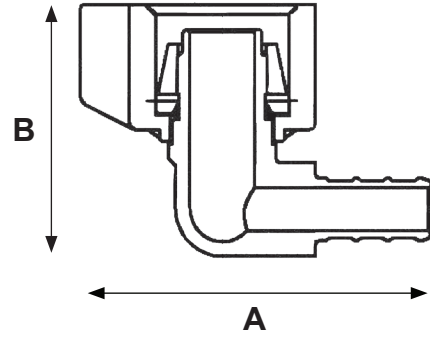

Tees

Dimensions (Inches)			
Part #	Size	A	B
UC360LF	3/8 in. x 3/8 in. x 3/8 in.	1.9	1.1
UC362LF	1/2 in. x 1/2 in. x 1/2 in.	1.9	1.2
UC370LF	3/4 in. x 3/4 in. x 3/4 in.	2.2	1.4
UC374LF	1 in. x 1 in. x 1 in.	2.8	1.9
UC0835	1-1/4 in. x 1-1/4 in. x 1-1/4 in.	3.3	2.2
UC0841	1-1/2 in. x 1-1/2 in. x 1-1/2 in.	3.9	2.6
UC0854	2 in. x 2 in. x 2 in.	5.2	3.5
UC366LF	5/8 in. x 5/8 in. x 5/8 in.	2.0	1.3

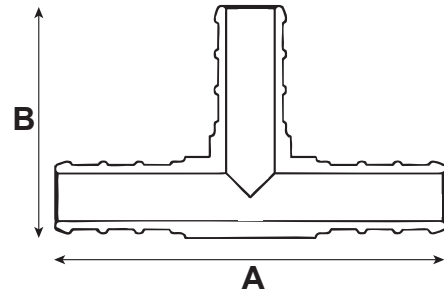

Reducing Tees

Dimensions (Inches)			
Part #	Size	A	B
UC363LF	1/2 in. X 1/2 in. X 3/8 in. Reducing Tee	1.9	1.2
UC364LF	3/8 in. X 3/8 in. X 1/2 in. Reducing Tee	1.9	1.2
UC408LF	1/2 in. X 1/2 in. X 3/4 in. Reducing Tee	2.1	1.3
UC412LF	3/4 in. X 3/4 in. X 1/2 in. Reducing Tee	2.0	1.4
UC413LF	3/4 in. X 3/4 in. X 1 in. Reducing Tee	2.3	1.7
UC414LF	1 in. X 3/4 in. X 3/4 in. Reducing Tee	2.4	1.7
UC415LF	1 in. X 1 in. X 1/2 in. Reducing Tee	2.6	1.7
UC416LF	1 in. X 1 in. X 3/4 in. Reducing Tee	2.6	1.7
UC417LF	3/4 in. X 3/4 in. X 3/8 in. Reducing Tee	2.0	1.4
UC418LF	1 in. X 3/4 in. X 1 in. Reducing Tee	2.6	1.9
UC434LF	1/2 in. X 3/8 in. X 1/2 in. Reducing Tee	1.9	1.2
UC444LF	3/4 in. X 1/2 in. X 3/4 in. Reducing Tee	2.2	1.4
UC452LF	1/2 in. x 3/8 in. x 3/8 in. Reducing Tee	1.9	1.2
UC454LF	3/4 in. X 1/2 in. X 1/2 in. Reducing Tee	2.0	1.4
UC08352828	1-1/4 in. x 1 in. x 1 in. Reducing Tee	3.0	2.1
UC08353516	1-1/4 in. x 1-1/4 in. x 1/2 in. Reducing Tee	2.7	2.2
UC08353522	1-1/4 in. x 1-1/4 in. x 3/4 in. Reducing Tee	2.9	1.9
UC08353528	1-1/4 in. x 1-1/4 in. x 1 in. Reducing Tee	3.1	2.1
UC08413528	1-1/2 in. x 1-1/4 in. x 1 in. Reducing Tee	3.3	2.3
UC08414116	1-1/2 in. x 1-1/2 in. x 1/2 in. Reducing Tee	3.1	2.0
UC08414122	1-1/2 in. x 1-1/2 in. x 3/4 in. Reducing Tee	3.3	2.0
UC08414128	1-1/2 in. x 1-1/2 in. x 1 in. Reducing Tee	3.5	2.3
UC08414135	1-1/2 in. x 1-1/2 in. x 1-1/4 in. Reducing Tee	3.8	2.4
UC08545416	2 in. x 2 in. x 1/2 in. Reducing Tee	3.7	2.6
UC08545422	2 in. x 2 in. x 3/4 in. Reducing Tee	3.9	2.6
UC08545428	2 in. x 2 in. x 1 in. Reducing Tee	4.2	2.8
UC08545441	2 in. x 2 in. x 1-1/2 in. Reducing Tee	4.8	3.1

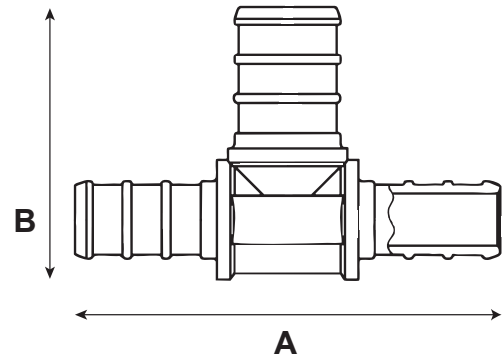

Plugs

Dimensions (Inches)			
Part #	Size	A	B
UC0435	1-1/4 in.	1.1	1.3
UC0441	1-1/2 in.	1.4	1.4
UC0454	2 in.	1.9	1.7
UC512LF	3/8 in.	0.7	0.5
UC514LF	1/2 in.	0.7	0.5
UC518LF	3/4 in.	0.7	0.8
UC520LF	1 in.	1.0	1.0

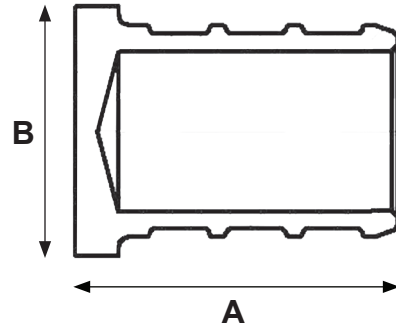

Water Softener Fitting

Dimensions (Inches)			
Part #	Size	A	B
UC086LF	3/4 in. X 1 in.	1.5	1.7

